

Bodengruppe (Oberseite)	Spannung	Baugruppe	Ausgabe	gültig ab Seriennummer
Bottom (Top elevation)	Voltage	Group	Edition	Application from Serial.No.
	3 N AC 400V 50Hz	10	10.1.1	C61D93065001

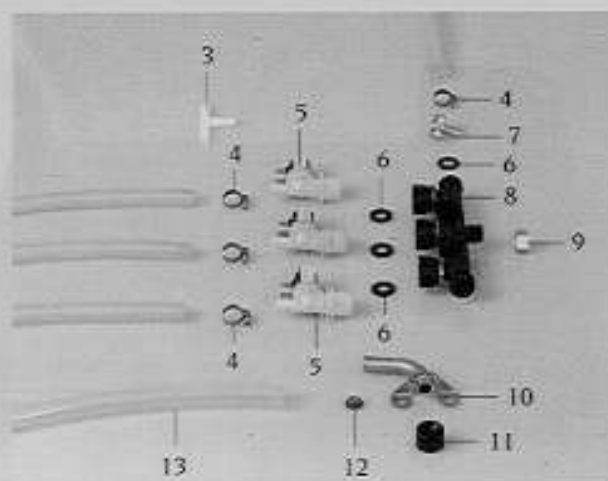

Pos.	St.	Ersatz.Nr.	Bezeichnung	Description
Pos.	Pcs.	Sp. Part No.		
-	-	2067.0050	Silikonschlauch 1m	Silicone hose 1m
1	4	2039.0112	Fußoberteil	Upper part of pedestal
2	4	2039.0113	Fußunterteil	Lower part of pedestal
3	1	2062.0302	T-Stück TS10	T-piece TS 10
4	4	2066.0205	Schlauchschelle 12-18mm	Hose clamp 12-18mm
5	3	3002.0331	Einfachmagnetventil kpl. 220-240V/50Hz	Single solenoid valve unit 220-240V/50Hz
6	4	5110.1024	Dichtung für Verschraubung G 3/4"	Gasket for G3/4" threaded joint
7	1	2062.0314	Geradeverschraubung G 3/4	Straight threaded joint G 3/4
8	1	8664.1007	Wasserverteiler	Water distribution unit
9	1	1500.1261	Verschlußkappe G1/2"	Screw cap G1/2"
-	1	5012.0539	Dichtung für Verschraubung G 1/2"	Gasket for G1/2" threaded joint
10	1	8455.1008	Tropfwannenverbinder	Connection for drip collector
11	1	2022.0204	Verbindungsstülpe f. Gerätetropfwanne	Connection grommet for drip collector
12	1	1106.0801	Sechskant-Combi-Mutter M 6	Hexagonal combination nut M6
13	1	2112.1010	Schlauch d 15x3x520 mm	Hose d 15x3x520 mm

Bodengruppe (Oberseite) Bottom (Top elevation) /	Spannung Voltage	Baugruppe Group	Ausgabe Edition	gültig ab Seriennummer Application from Serial.No.
	3 N AC 400V 50Hz	9	9.1.1	C61D93065001

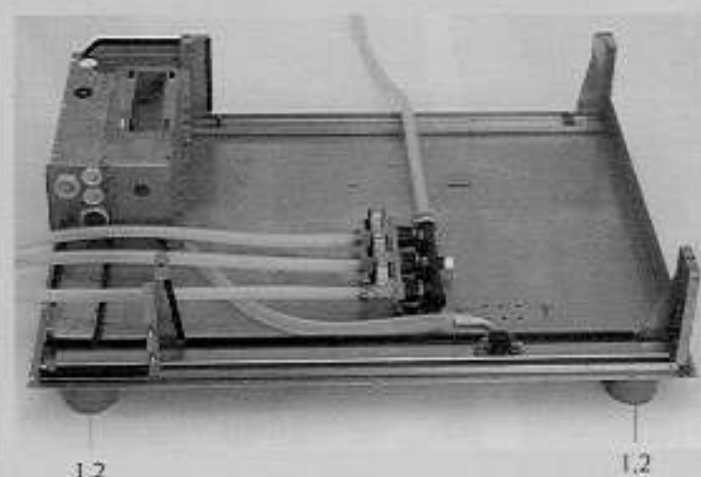
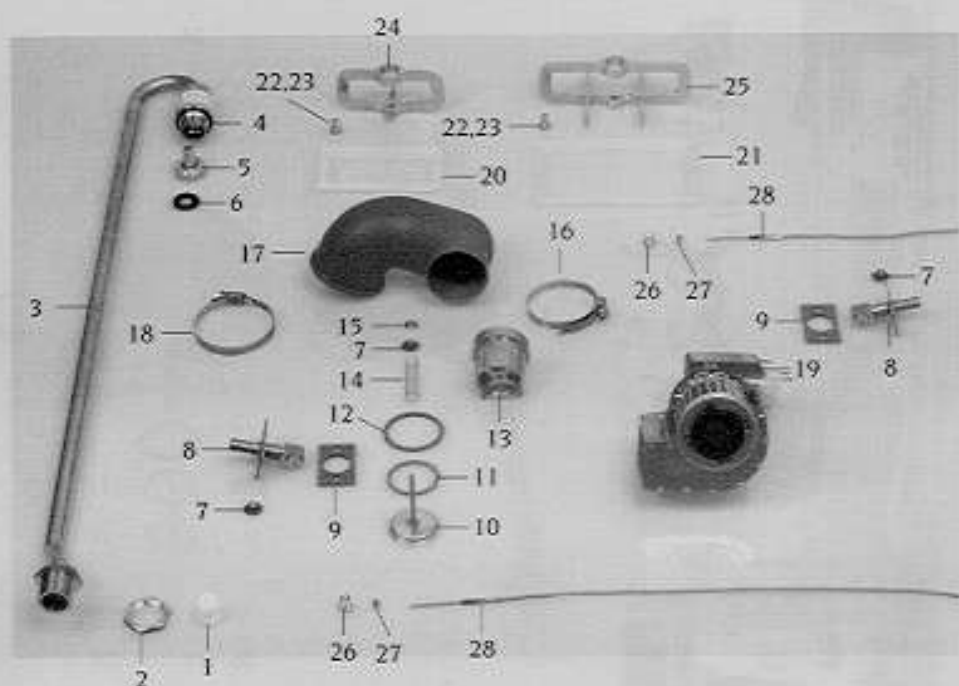

Pos.	St.	Ersatz-Nr.	Bezeichnung	Description
Pos.	Pcs.	Sp. Part No.		
-	1	8450.1001	Sicherheitsventil kpl.	Safety valve unit
1	1	1900.0202	Wasserfilter grob	Water filter coarse
2	2	2062.0313	Kontermutter G 3/4	Lock-nut G 3/4
3	1	2910.1031	Rohranschluß	Tube connection
4	1	2069.0102	Armaturenkombination	Valve unit with non-return valve
5	1	2062.0314	Geradeverschraubung G 3/4	Straight threaded joint G 3/4
6	1	5110.1024	Dichtung für Verschraubung G 3/4"	Gasket for G3/4" threaded joint
7	5	1105.0122	Sechskant-Combi-Mutter M 5	Hexagonal combination nut M5
8	2	8666.1021	Ablöschdüse kpl. 1,7l/min.	Quenching nozzle unit 1,7 l/min.
9	2	5110.1031	Dichtung Ablöschdüse	Gasket for quenching nozzle
10	1	2064.1001	Unterdruckstempel f. Sicherheitsventil	Vacuum/depression ram for safety valve
11	1	2064.1003	Unterdruckdichtung f. Sicherheitsventil	Vacuum/depression gasket for safety valve
12	1	2064.1004	Überdruckgewichtsdichtung f. Sicherheitsventil	Overpressure weight gasket for safety valve
13	1	2064.1000	Überdruckgewicht f. Sicherheitsventil	Overpressure weight for safety valve
14	1	2064.1002	Unterdruckfeder f. Sicherheitsventil	Vacuum/depression spring for safety valve
15	1	1107.0100	Schnellbefestiger 4,0 mm	Quick fastener 4,0 mm
16	1	2066.0504	Schlauchschele 40-60mm	Hose clamp 40-60mm
17	1	5012.0570	Haube f. Sicherheitsventil	Cap for safety valve
18	1	2066.0300	Schlauchschele 50-70mm	Hose clamp 50-70mm
19	1	3101.1003	Querstromlüfter	Cooling fan
20	1	5110.1026	Dichtung klein für Ablöschkanal/ Gerätedeckel	Small gasket for quenching channel/top cover
21	1	5110.1017	Dichtung groß für Ablöschkanal/ Gerätedeckel	Large gasket for quenching channel/top cover
22	2	1008.0751	Sechskantschraube M5x25	Hexagonal screw M 5x25
23	2	1315.0260	Unterlegscheibe A5,3	Washer A5,3
24	1	2940.1017	Fixierung klein für Gerätedeckel	Small fixing for top cover
25	1	2940.1015	Fixierung groß für Gerätedeckel	Large fixing for top cover
26	2	3014.0163	Stopfbuchsnippel für Thermoelement	Gasket sleeve with nipple
27	2	3014.0162	Dichtkegel für Thermoelement	Sealing cone for thermo element
28	2	3014.0161	Mantelthermoelement	Sheath thermo element
29	1	8666.1049	Ablöschdüse Ablaufkasten	Quenching nozzle for outlet box

Bedienblende Control Panel	Spannung Voltage 3 N AC 400V 50Hz	Baugruppe Group 1	Ausgabe Edition 1.1.1	gültig ab Seriennummer Application from Serial.No. C61D93065001
-------------------------------	---	-------------------------	-----------------------------	---

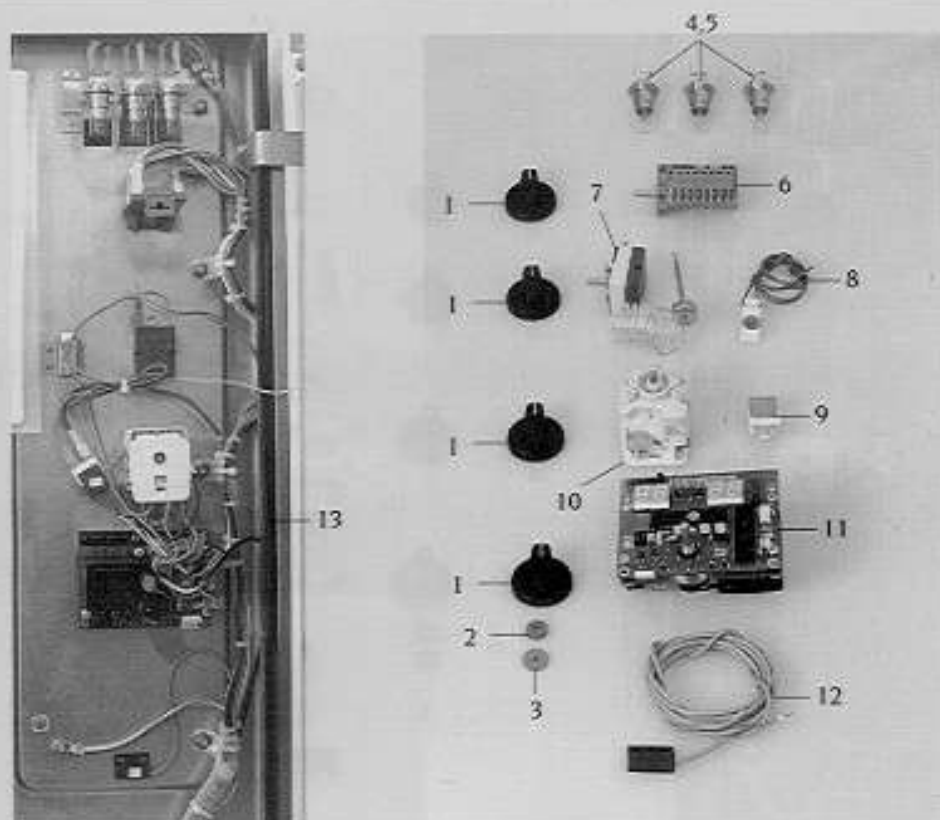

Pos.	St.	Ersatz.Nr.	Bezeichnung	Description
Pos.	Pcs.	Sp. Part No.		
1	4	3013.0344	Knebel CCD/CCM blau Ø 60mm	Dial CCD/CCM blue Ø 60mm
		3013.0330	Knebel CCD/CCM blau Ø 40mm	Dial CCD/CCM blue Ø 40mm
2	4	2022.0100	Silikon-Dichtscheibe	Silicone gasket
3	4	5110.1027	Distanzscheibe 61-202	Distance plate 61-202
4	3	3024.0305	Fassung für Kontrolleuchte	Socket for control lamp
5	3	3025.0306	Glühlampe für Kontrolleuchte	Bulb for control lamp
6	1	3016.1612	Betriebsartenschalter CCD	Mode switch block type CCD
7	1	3014.0166	Thermostat Heißluft/ Gerät zu heiß	Thermostat hot air/ unit too hot
8	1	3024.0307	Heizungskontrolleuchte	Heating control lamp
9	1	3006.0101	Alarmsummer	Alarm buzzer
10	1	3013.0104	Zeitschaltuhr 120min.	Timer 120 min.
11	1	3035.0660	Kerntemperaturregelung	PCB for core temperature
12	1	3016.1408	Türkontaktschalter	Door contact switch
13	1	5105.1011	Dichtungsrahmen f. Bedienblende	Gasket frame for panel

Bedienblende Control panel	Spannung Voltage	Baugruppe Group	Ausgabe Edition	gültig ab Seriennummer Applicable from Serial.No.
	3 N AC 400V 50Hz	1	1.1.2	C61D95057001

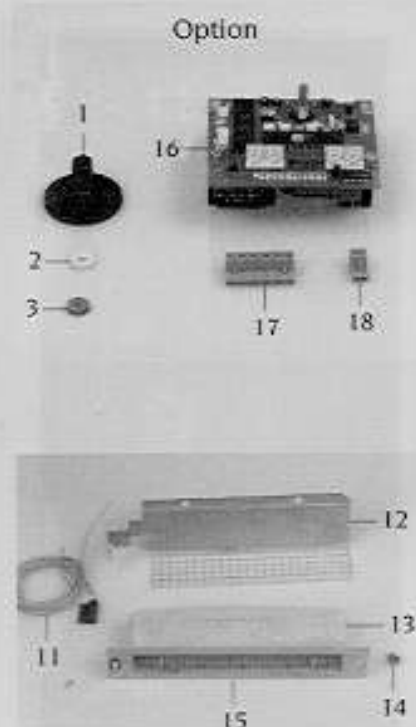
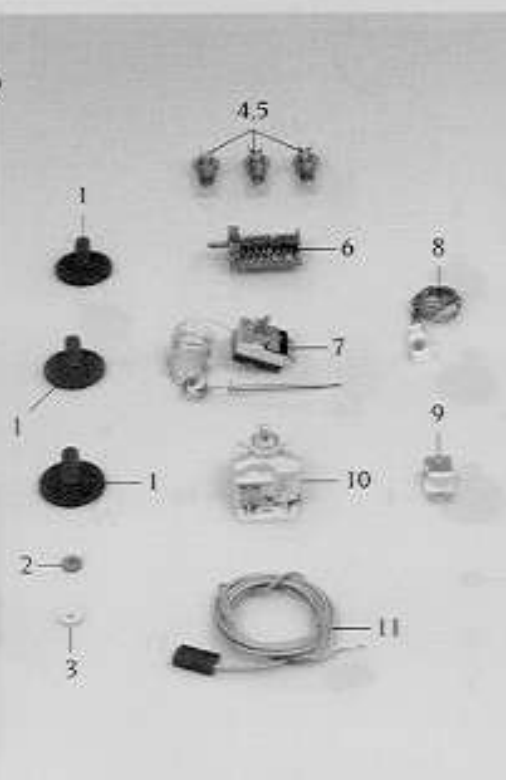

Pos.	St.	Ersatz.Nr.	Bezeichnung	Description
Pos.	Pcs.	Sp. Part No.		
-	1	8720.1205	Bedienblende mit Folie	Control panel with overlay
-	1	8720.1242	Bedienblende mit Folie und Kerntemperatur	Control panel with overlay and core temperature
-	1	8464.1200	Filterträger kpl.	Air inlet filter cpl.
1	3(4)	3013.0344	Knebel blau	Dial blue
2	3(4)	5110.1029	Dichtung für Betriebsartenschalter	Gasket mode switch
3	3(4)	5110.1027	Distanzscheibe	Distance plate
4	3	3024.0305	Fassung für Kontrolleuchte	Socket for control lamp
5	3	3025.0306	Glühlampe für Kontrolleuchte	Bulb for control lamp
6	1	3016.1612	Betriebsartenschalter	Mode switch block
7	1	3014.0166	Thermostat Heißluft/ Gerät zu heiß	Thermostat hot air/ unit too hot
8	1	3024.0307	Heizungskontrolleuchte	Heating control lamp
9	3006.0101	Alarmsummer	Alarm buzzer	
10	1	3013.0104	Zeitschaltuhr 120min. 50Hz	Timer 120 min. 50Hz
11	2	3016.1408	Türkontaktschalter	Door contact switch
-	1	3016.1409	Magnet rund Tischgeräte	Magnet round table models
12	1	2712.1200	Türkontaktträger	Door contact mounting bracket
-	2	1103.0600	Spreizmutter 2mm	Expansion nut 2mm for self-tapping screw
-	2	1304.0150	Unterlegscheibe A3.2	Washer A3.2
-	2	1003.2160	Sechskant Blechschraube A2.9x9.5	Hex self-tapping screw A2.9x9.5
13	1	5214.1208	Filtermatte	Filter gaze
14	2	2043.0205	Verschlußbolzen	Locking pin
15	1	8464.1201	Filterträger	Air inlet filter
16	1	3035.0660	Kerntemperaturregelung	PVB for core temperature
17	1	3040.0172	Steckerleiste BL 2	Multipoint connector BL 2
18	1	3040.0173	Steckerleiste BL 6	Multipoint connector BL 6
19	1	5105.1011	Dichtungsrahmen f. Bedienblende	Gasket frame for panel

Gerätetür Door	Spannung Voltage	Baugruppe Group	Ausgabe Edition	gültig ab Seriennummer Application from Serial.No.
	3 N AC 400V 50Hz	8	8.1.1	C61D93065001

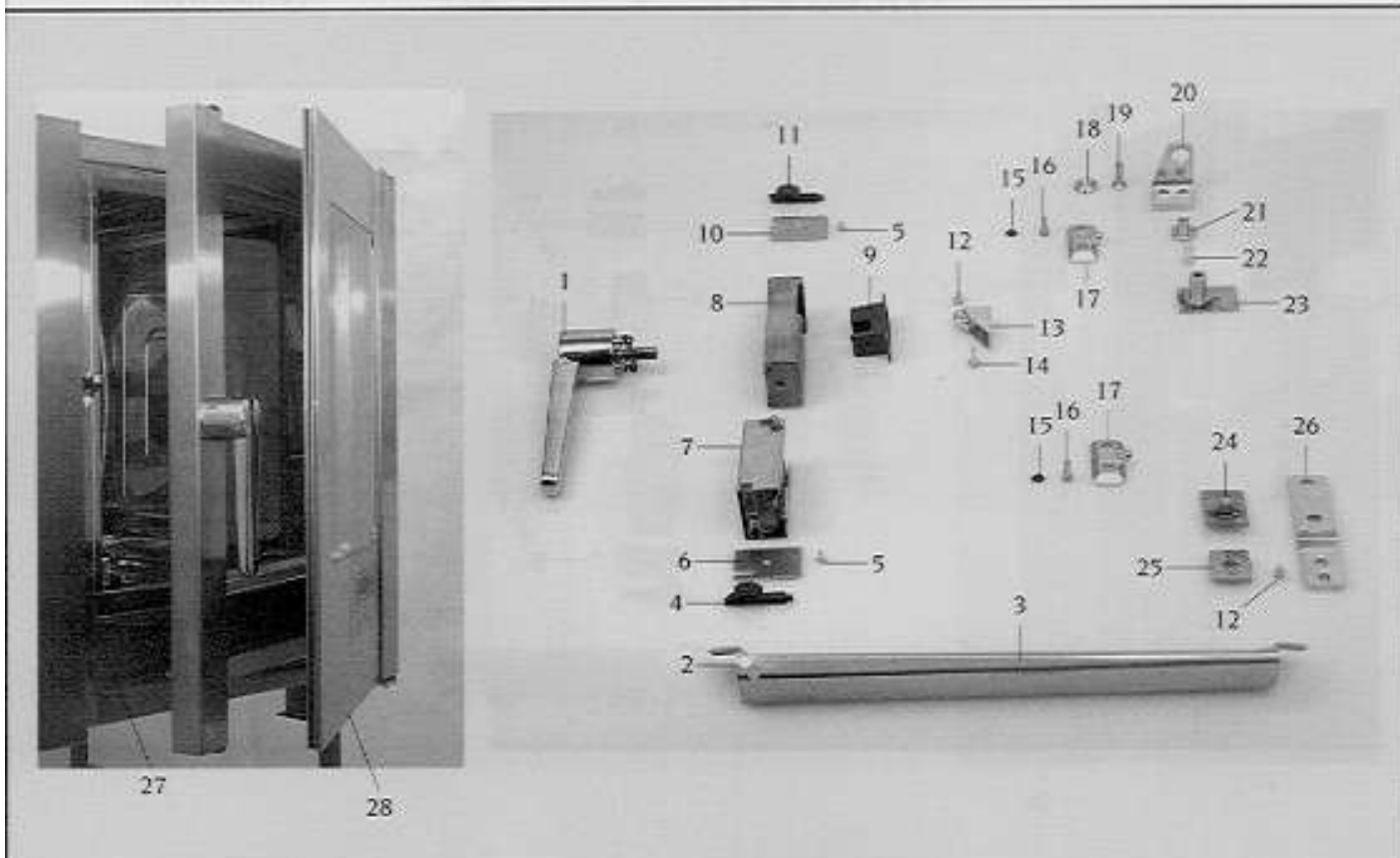

Pos.	St.	Ersatz.Nr.	Bezeichnung	Description
Pos.	Pcs.	Sp. Part No.		
-	1	8470.1002	Türe kpl.	Door unit
-	1	5105.1001	Dichtungsrahmen f. Türe/Garraum	Gasket frame for door/interior cabinet
1	1	2016.1500	Türgriff kpl.	Door-handle unit
2	1	2039.0321	Gleitkuppe f. Tropfwanne	Plastic knob for door drip collector
3	1	8474.1014	Türtropfwanne kpl.	Door drip collector
4	1	2043.0102	Riegel unten f. Außentüre	Lower bolt for external door
-	2	2001.0112	Druckfeder d 0.5x23 mm	Compression spring d 0.5x23 mm
5	4	1004.0430	Senkschraube m. Schlitz M4x16	Slotted countersunk-head screw M4x16
6	1	2760.1050	Deckel unten Verschlußseitig	Lower lid on the side of the seal
7	1	8474.1008	Einschub kpl. f. Türe unten	Plug-in unit for bottom door
8	1	8474.1001	Verschluß kpl. f. Türgriff	Lock for door-handle
9	1	2039.0319	Abdeckung f. Schloß Innenseite	Internal lock cover
10	1	2760.1049	Deckel oben Verschlußseitig	Upper lid on the side of the seal
11	1	2043.0101	Riegel oben f. Außentüre	Upper bolt for external door
12	3	1005.2000	Sperrzahnschraube M 5x8	Interlocking tooth screw M 5x8
13	1	2016.0610	Fangkloben kpl. Tischgeräte	Door catch unit
14	2	1005.2100	Sperrzahnschraube M 5x16	Interlocking tooth screw M5x16
15	5	2039.0309	Abdeckkappe f. Türe	Cap for door
16	4	1006.7601	Innensechskantschraube M 6x16	Allen screw M6x16
17	2	2060.1600	Lagerbock f. Außenscheibe	Bearing pedestal for external window
18	1	2120.1010	Unterlegscheibe 25x4mm	Washer 25x4mm
19	1	1008.1960	Senkschraube m. Innensechskant M 8x30	Countersunk-head screw M8x30
20	1	2930.1002	Türhaltewinkel oben	Door holding angle top
21	1	2120.1009	Türhaltebolzen oben	Door holding bolt top
22	1	2001.0111	Druckfeder f. Türhaltebolzen	Compression spring for door holding pin
23	1	8474.1009	Deckel oben kpl. drehpunktseitig	Upper lid unit at side of the pivot
24	1	8474.1010	Deckel unten kpl. drehpunktseitig	Lower lid unit at side of the pivot
25	1	2930.1001	Rasteller	Locking plate bottom
26	1	2930.1000	Türkonsole unten	Lower door console
27	1	8455.1007	Gerätetropfwanne	Drip collector
28	1	8474.1005	Glasscheibe außen kpl.	External glass pane unit
-	1	5105.1001	Dichtungsrahmen für Glasscheibe	Gasket frame for internal glass panel

Elektromontageplatte Electrical Installation	Spannung Voltage	Baugruppe Group	Ausgabe Edition	gültig ab Seriennummer Application from Serial.No.
	3 N AC 400V 50Hz	2	2.1.1	C61D93065001

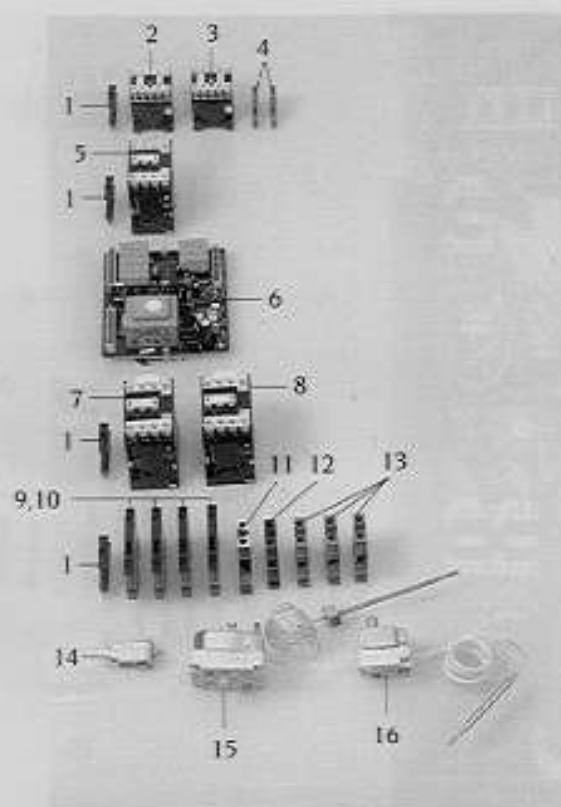
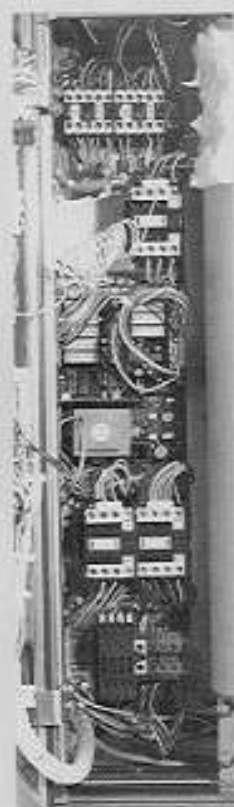

Pos.	St.	Ersatz.Nr.	Bezeichnung	Description
Pos.	Pcs.	Sp. Part No.		
1	4	4001.1203	Endklammer für Tragschiene	End plate for supporting rail
2	1	3028.0504	Schütz LS 05.01 230V 50/60Hz	Contacteur LS 05.01 230V 50/60Hz
3	1	3028.0504	Schütz LS 05.01 230V 50/60Hz	Contacteur LS 05.01 230V 50/60Hz
4	2	4001.1216	Reihenklemme 4qmm grau	Terminal 4qmm grey
5	1	3028.0508	Schütz LS 17.10 220-240V 50/60Hz	Contacteur LS 17.10 220-240V 50/60Hz
6	1	3040.2060	Regelplatte Wasserstand	PCB water level
-	2	3040.0245	Steckerleiste BL 11	Multipoint connector BL 11
-	1	3040.0244	Steckerleiste BL 10	Multipoint connector BL 10
7	1	3028.0508	Schütz LS 17.10 220-240V 50/60Hz	Contacteur LS 17.10 220-240V 50/60Hz
8	1	3028.0506	Schütz LS 04.10 220-240V 50/60Hz	Contacteur LS 04.10 220-240V 50/60Hz
9	4	4001.1247	Sicherungsklemme	Safety terminal
10	4	4001.0218	Feinsicherung 6.3A	Fuse 6.3A
11	1	4001.1210	Erdungsreihenklemme 16qmm gelb/grün	Earth terminal 16qmm yellow/green
12	1	4001.1250	Reihenklemme 16qmm blau	Terminal 16qmm blue
13	3	4001.1202	Reihenklemme 16qmm grau	Terminal 16qmm grey
14	1	3014.0400	Überstromauslöser einpolig f. Motorschutz	Current limiter for motor protection
15	1	3014.0322	Sicherheitstemperaturbegrenzer 360°C	Safety temperature limiter 360°C
16	1	3014.0300	Trockengeschutz 125 °C	Dry up protector 125 °C
-	1	3102.1000	Wechselspannungskondensator 1,5 uF,250V	Capacitor 1,5 uF,250V AC

Elektromontageplatte Electrical installation	Spannung Voltage	Baugruppe Group	Ausgabe Edition	gültig ab Seriennummer Applicable from Serial.No.
	3 N AC 400V 50Hz	3	3.1.2	C61D95057001

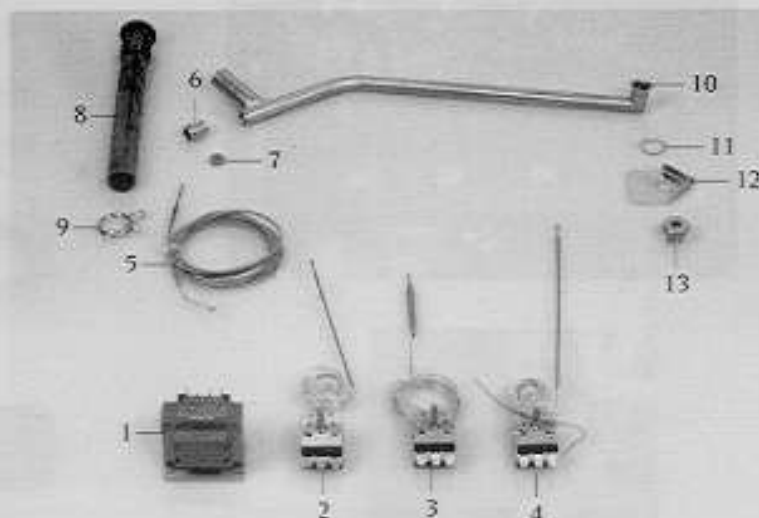
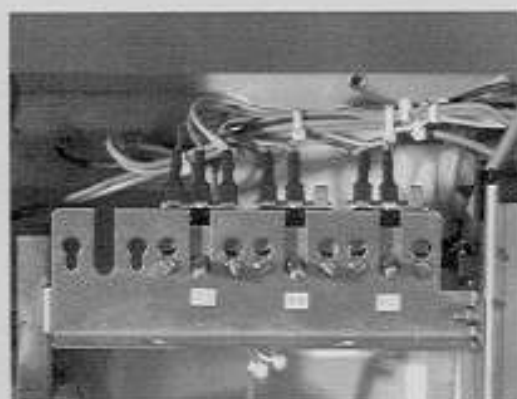

Pos. St. Pos. Pcs.	Ersatz.Nr. Sp. Part No.	Bezeichnung	Description
1	1	3037.0205	Halogenrafo 10VA Halogen transformer 10VA
2	1	3014.0166	Thermostat Heißluft/ Gerät zu heiß Thermostat hot air/ unit too hot
3	1	3014.0314	Thermostat Dampfgenerator Thermostat for steam generator
4	1	3014.0312	Thermostat Ablöschung Thermostat for quenching
5	1	3014.0161	Mantelthermoelement kurz Sheath thermo element short
6	1	4007.0600	Kabelverschraubung PG 9 Screw-type conduit fitting PG 9
7	1	2022.0100	Silikon-Dichtscheibe d 12x2 Silicone gasket d 12x2
8	1	4016.0103	Anschlußstülle 125mm lang Bypass grommet 125mm long
9	1	2066.0521	Schlauchklemme 27mm Hose clamp 27mm
10	1	2910.1210	Bypassrohr Bypass pipe
11	1	1315.0104	Kupferdichtung 16x20 mm Copper gasket 16x20 mm
12	1	2760.1262	Bypass-Abweiser Bypass deflector
13	1	2016.0941	Bypassdüse Bypass nozzle

Elektromontageplatte Electrical Installation	Spannung Voltage	Baugruppe Group	Ausgabe Edition	gültig ab Seriennummer Application from Serial.No.
	3 N AC 400V 50Hz	3	3.1.1	C61D93065001

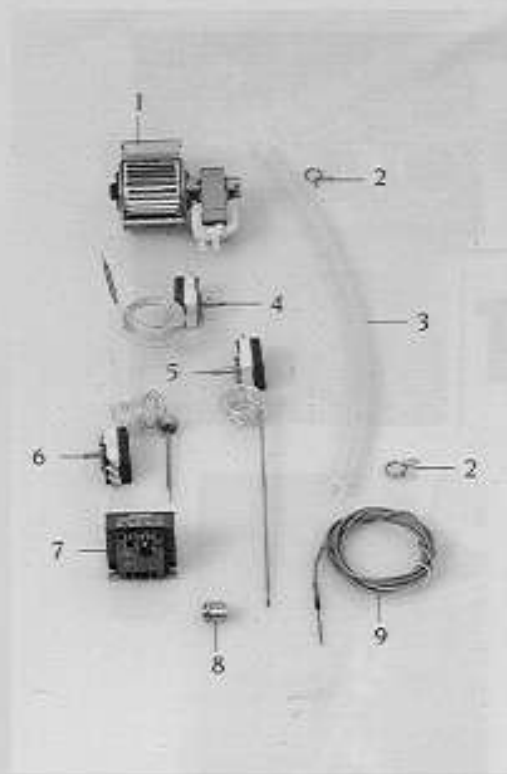
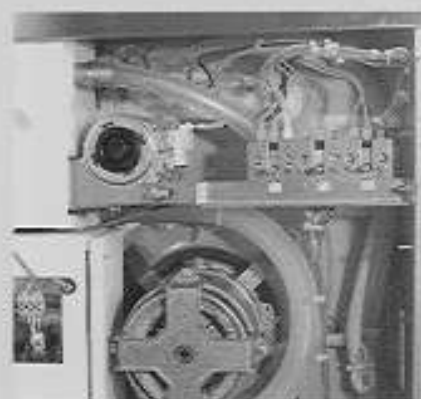

Pos.	St.	Ersatz.Nr.	Bezeichnung	Description
Pos.	Pcs.	Sp. Part No.		
1	1	3101.1003	Querstromlüfter	Cooling fan for electrical installation room
2	2	2066.0525	Schlauchklemme 22,1mm	Hose clamp 22.1mm
3	1	2112.1021	Silikon Schlauch 15x3x600mm	Silicone hose 15x3x600mm
4	1	3014.0166	Thermostat Gerät zu heiß	Thermostat unit too hot
5	1	3014.0312	Thermostat Ablöschung	Thermostat for quenching
6	1	3014.0314	Thermostat Dampfgenerator	Thermostat for steam generator
7	1	3037.0205	Halogentrafo 10VA	Halogen transformer 10VA
8	1	4007.0600	Kabelverschraubung PG 9	Cable gland PG9
-	1	4006.0601	Sechskantmutter für PG9	Hex screw for PG9
9	1	3014.0161	Mantelthermoelement	Sheath thermo element
-	1	3014.0162	Dichtkegel für Thermoelement	Sealing cone for thermo element
-	1	3014.0163	Stopfbuchsnippel für Thermoelement	Gasket sleeve with nipple

Handbrause Hand Shower	Spannung Voltage	Baugruppe Group	Ausgabe Edition	gültig ab Seriennummer Application from Serial.No.
	3 N AC 400V 50Hz	11	11.1.1	C61D93065001

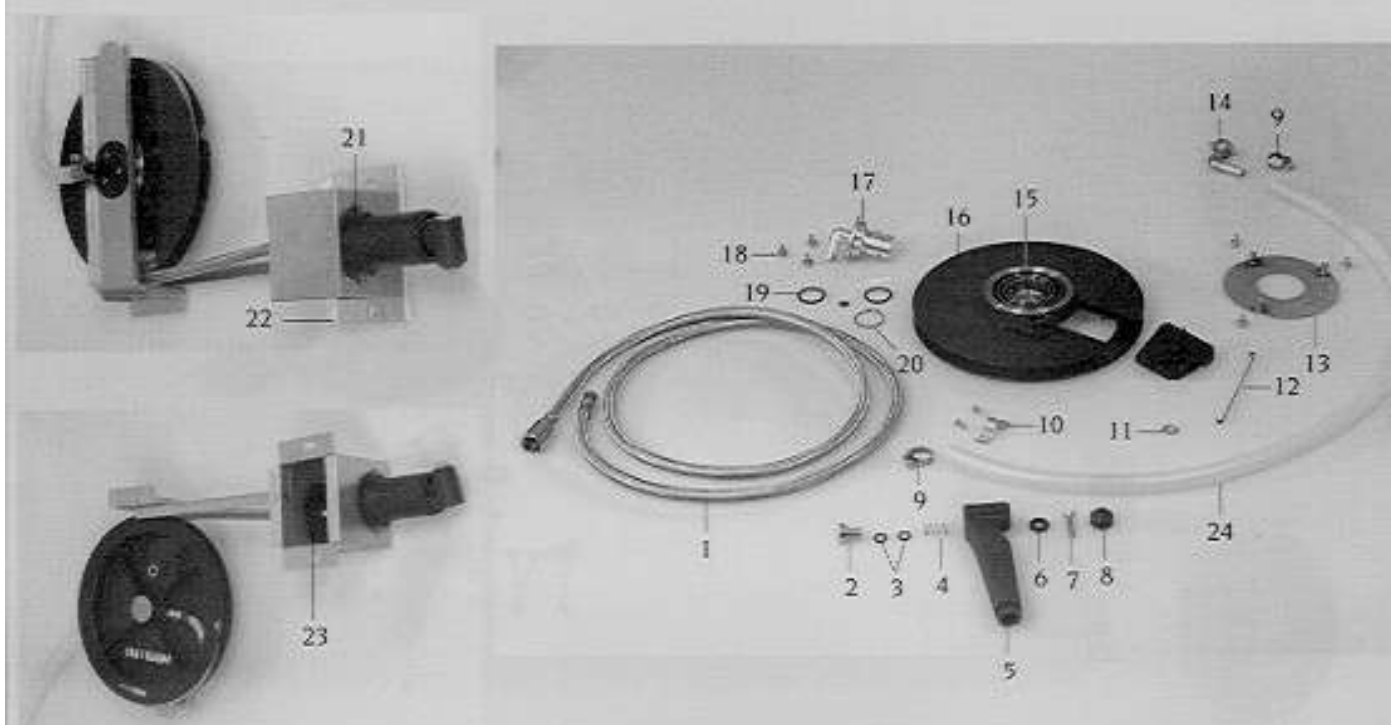

Pos.	St.	Ersatz.Nr.	Bezeichnung	Description
Pos.	Pcs.	Sp. Part No.		
-	1	8655.2000	Schlauchroller kpl.	Hand shower roll guide
1	1	2067.0605	Brauseschlauch 1500 mm	Shower hose 1500 mm
	2	2060.0228	O-Ring	O-ring
2	1	2060.1001	Druckknopf für Handbrause	Push-button for hand shower
3	2	5012.0559	O-Ring f. Schlauchbrause d 7x2,5mm	O-ring d 7x2,5mm
4	1	2001.0110	Druckfeder f. Schlauchbrause	Compression spring
5	1	2060.1000	Handbrause kpl. (inkl.Pos 2-8)	Hand shower (incl.Pos 2-8)
6	1	5012.0558	O-Ring f. Schlauchbrause d 8x5mm	O-ring d 8x5mm
7	1	2060.1003	Steilkegelstift Handbrause	Steep taper pin for hand shower
8	1	2060.1002	Düse f. Handbrause	Jet for hand shower
9	2	2066.0205	Schlauchschnelle 12-18mm	Hose clamp 12-18mm
10	1	2760.1159	Befestigungsschnelle	Hose clamp
-	2	1003.0231	Kerbschraube 3,9x13 mm	Slotted screw 3.9 x 13 mm
11	1	2001.0203	Feder Mutter d 8mm	Spring nut d 8 mm
12	1	2001.0202	Bügel Feder f. Schlauchroller	Return spring for hose roll guide
13	1	8655.2005	Sicherungsscheibe	Locking plate
14	1	2062.0208	Winkelverschraubung G1/2"x10	Elbow screw point G1/2"x10
-	1	5012.0539	Dichtung für Verschraubung G 1/2"	Gasket for G1/2" threaded joint
15	1	2001.0201	Spiralfeder f. Schlauchroller	Spiral coiled spring for hose roll guide
16	1	2060.0150	Schlauchrad für Handbrause	Retractable wheel for hand shower
17	1	2060.0157	Achse f. Schlauchroller	Axle for hose roll
18	3	1005.2000	Sperrzahnschraube M5x8	Interlocking tooth screw M5x8
19	1	8000.0081	Satz O-Ringe	Set O-ring
20	1	1250.0103	Sicherungsring 28mm	Snap ring 28mm
21	1	2060.1005	Handbrauseaufnahme	Hand shower intake
22	1	5110.1020	Dichtung f. Spritzschutz Handbrause	Gasket for splash guard hand shower
23	2	5110.1021	Dichtscheibe f. Spritzschutz Handbrause	Seal ring for splash guard hand shower
24	1	2067.0164	Silikon Schlauch 650mm	Silicone hose 650mm

Handbrause Hand shower	Spannung Voltage	Baugruppe Group	Ausgabe Edition	gültig ab Seriennummer Applicable from Serial.No.
	3 N AC 400V 50Hz	11	11.1.2	C61D95057001

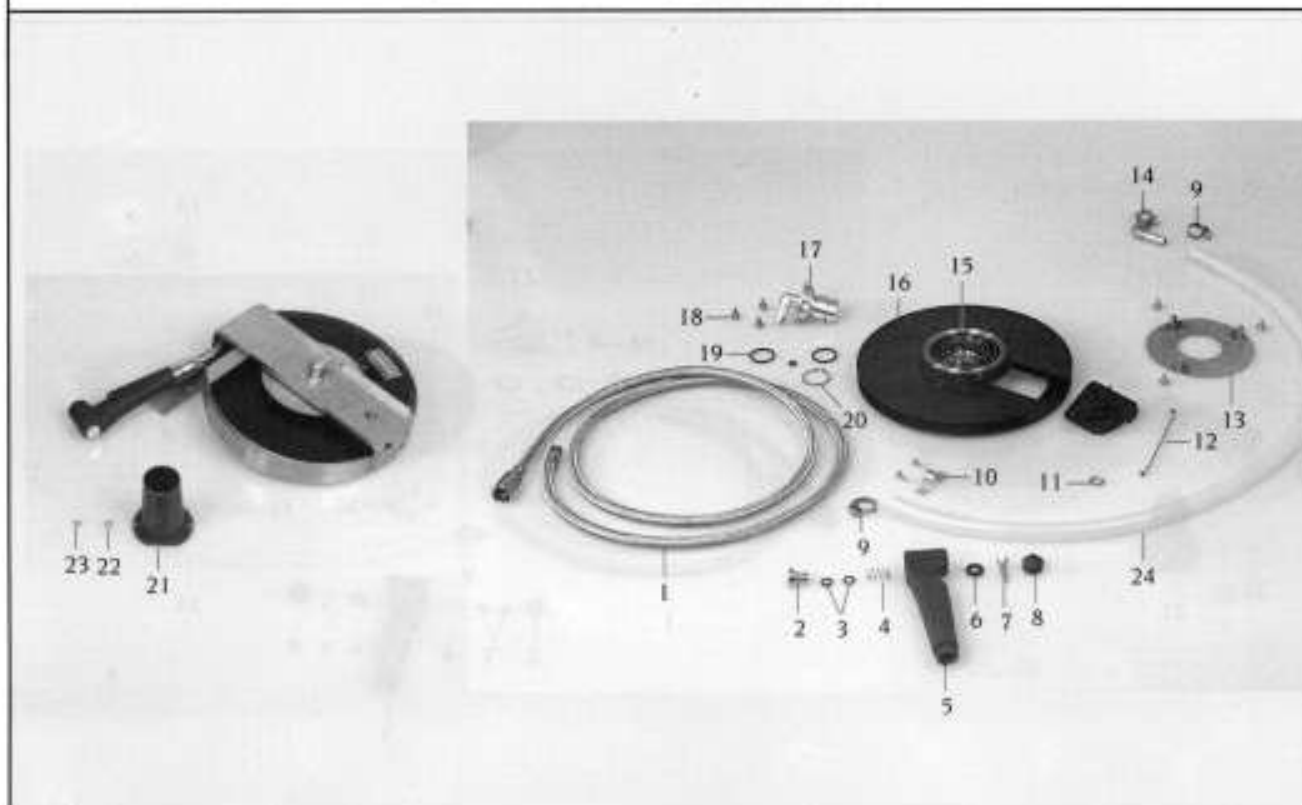

Pos.	St.	Ersatz.Nr.	Bezeichnung	Description
Pos.	Pcs.	Sp. Part No.		
-	1	8655.2006	Schlauchroller kpl.	Hand shower roll guide
1	1	2067.0605	Brauseschlauch 1500 mm	Shower hose 1500 mm
-	2	2060.0228	O-Ring für Brauseschlauch	O-ring for shower hose
2	1	2060.1001	Druckknopf für Handbrause	Push-button for hand shower
3	2	5012.0559	O-Ring f. Schlauchbrause d 7x2,5mm	O-ring for hand shower d 7x2,5mm
4	1	2001.0110	Druckfeder f. Schlauchbrause	Compression spring for hand shower
5	1	2060.1000	Handbrause	Hand shower
6	1	5012.0558	O-Ring f. Schlauchbrause d 8x5mm	O-ring for hand shower d 8x5mm
7	1	2060.1003	Steilkegelstift Handbrause	Steep taper pin for hand shower
8	1	2060.1002	Düse f. Handbrause	Nozzle for hand shower
9	2	2066.0205	Schlauchschnelle 12-18mm	Hose clamp 12-18mm
10	1	2760.1159	Befestigungsschelle	Fixing clip
-	2	1003.0231	Kerbschraube 3,9x13 mm	Slotted screw 3.9 x 13 mm
11	1	2001.0203	Federmutter d 8mm	Spring nut d 8 mm
12	1	2001.0202	Bügel Feder f. Schlauchroller	Return spring for hose roll guide
13	1	8655.2005	Haltescheibe für Spiralfeder	Locking disc for spiral coiled spring
14	1	2062.0208	Winkelverschraubung G1/2"x10"	Elbow screw point G1/2"x10"
-	1	5012.0539	Dichtung für Verschraubung G 1/2"	Gasket for G1/2" threaded joint
15	1	2001.0201	Spiralfeder f. Schlauchroller	Spiral coiled spring for hose roll guide
16	1	2060.0150	Schlauchrad für Handbrause	Retractable wheel for hand shower
17	1	2060.0157	Achse für Schlauchroller	Axle for hose roll
18	3	1005.2000	Sperrzahnschraube M 5x8	Interlocking tooth screw M 5x8
19	1	8000.0081	Satz O-Ring	Set O-ring
20	1	1250.0103	Sicherungsring 28mm	Guard ring 28mm
21	1	2060.1200	Aufnahme für Handbrause	Hand shower intake
22	2	1304.0150	Unterlegscheibe A3,2	Washer A3,2
23	2	1103.0120	Sechskantmutter M 3	Hexagonal nut M3

Heißluftheizung Hot Air Heating	Spannung Voltage	Baugruppe Group	Ausgabe Edition	gültig ab Seriennummer Application from Serial.No.
	3 N AC 400V 50Hz	5	5.1.1	C61D93065001

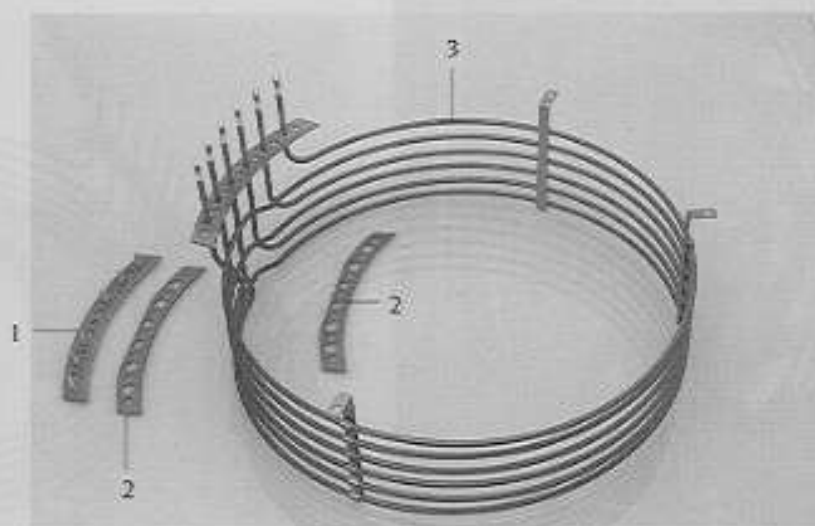
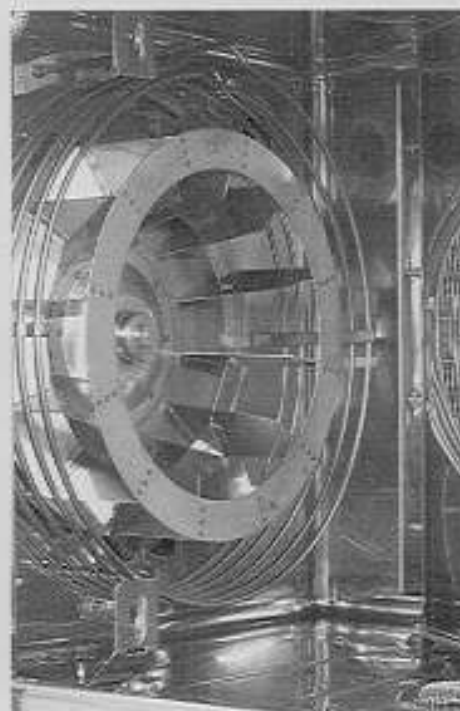

Pos.	St.	Ersatz.Nr.	Bezeichnung	Description
Pos.	Pcs.	Sp. Part No.		
1	1	2150.1005	Flansch Außenseite f. Heizregister	External flange for heating element
2	2	5110.1009	Dichtring f. Heizregister	Seal ring for heating assembly
-	9	1106.0360	Hutmutter M6	Cap nut M6
-	9	1206.0261	Federring B6	Spring washer B6
3	1	3200.1000	Heizregister innen 230V	Inner heating assembly 230V

Garraum Interior Cabinet	Spannung Voltage	Baugruppe Group	Ausgabe Edition	gültig ab Seriennummer Application from Serial.No.
	3 N AC 400V 50Hz	7	7.1.1	C61D93065001

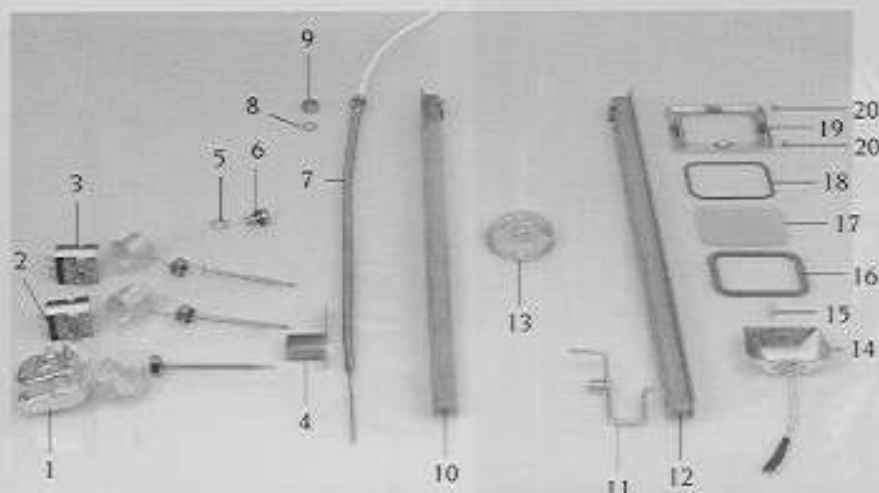
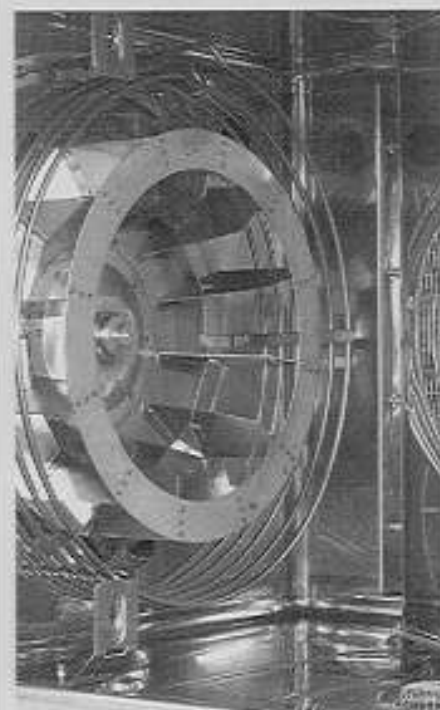

Pos.	St.	Ersatz.Nr.	Bezeichnung	Description
Pos.	Pcs.	Sp. Part No.		
-	-	8516.1029	Luftleitblech CCD 61	Air baffle CCD 61
1	1	3014.0322	Sicherheitstemperaturbegrenzer 360°C	Safety temperature limiter 360°C
2	1	3014.0166	Thermostat Heißluft/ Gerät zu heiß	Thermostat hot air/ unit too hot
3	1	3014.0166	Thermostat Heißluft/ Gerät zu heiß	Thermostat hot air/ unit too hot
4	1	2720.1073	Thermostathaltewinkel	Holding angle for thermostat
5	2	2043.0203	Haltescheibe für Verschlußbolzen	Holder plate for air baffle
6	2	2043.0201	Verschlußbolzen für Luftleitblech	Locking pin for air baffle
7	1	3035.0700	Einstechfühler	Meat probe sensor
8	1	1315.0105	Kupferdichtung für Einstechfühler	Copper gasket for meat probe sensor
9	1	1112.0110	Sechskantmutter M 10	Hexagonal nut M 10
10	1	8514.1023	Einfahrschiene links	Rail left
11	1	8514.1025	Sperrklinke f. Einfahrschiene rechts	Bolt for oven rack rail right
12	1	8514.1024	Einfahrschiene rechts	Rail right
13	1	2005.0300	Ablaufsieb	Outlet sieve
14	1	8514.1018	Reflektor kpl. f. Garraumbeleuchtung	Reflector unit for interior lighting
15	1	3024.0201	Halogengarraumlampe 10 W/12V/300°C	Halogen bulb 10 W/12V/300°C
16	1	5110.1023	Dichtungsrahmen innen	Internal gasket frame
17	1	5201.1000	Glas f. Garraumbeleuchtung	Glass for interior lamp
18	1	5110.1022	Dichtungsrahmen außen f. Garraumbeleuchtung	External gasket frame
19	1	8514.1017	Andrückrahmen f. Garraumbeleuchtung	Press down frame
20	4	1008.0753	Sechskantschraube M5x8	Hexagonal screw M5x8

Garraum Interior cabinet	Spannung Voltage	Baugruppe Group	Ausgabe Edition	gültig ab Seriennummer Applicable from SerialNo.
	3 N AC 400V 50Hz	7	7.1.2	C61D95057001

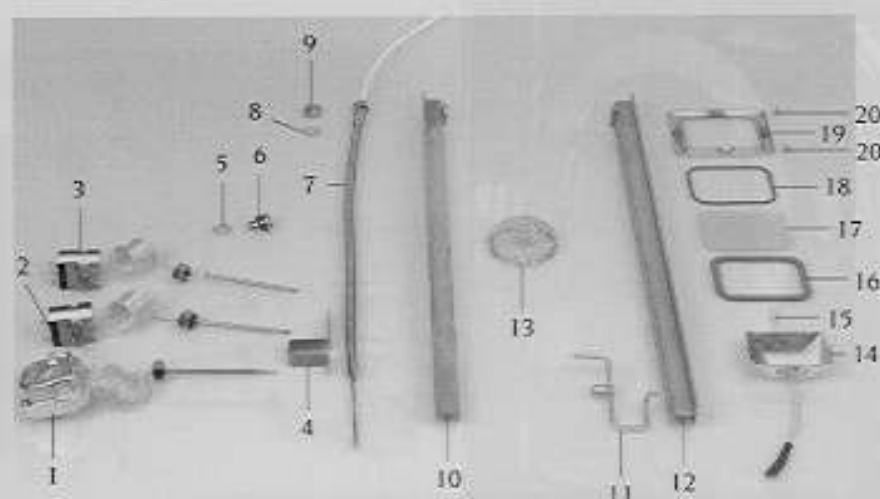
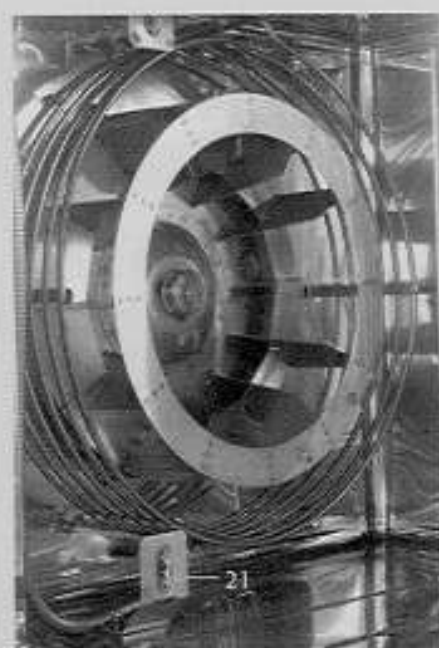

Pos.	St.	Ersatz.Nr.	Bezeichnung	Description
Pos.	Pcs.	Sp. Part No.		
-	-	8516.1025	Luftleitblech	Air baffle
1	1	3014.0322	Sicherheitstemperaturbegrenzer 360°C	Safety temperature limiter 360°C
2	1	3014.0166	Thermostat Heißluft/ Gerät zu heiß	Thermostat hot air/ unit too hot
3	1	3014.0166	Thermostat Heißluft/ Gerät zu heiß	Thermostat hot air/ unit too hot
4	1	2720.1073	Thermostathaltewinkel	Holding angle for thermostat
5	2	2043.0203	Haltescheibe für Verschlußbolzen	Holder plate for locking pin
6	2	2043.0201	Verschlußbolzen für Luftleitblech	Locking pin for air baffle
7	1	3035.0700	Einstechfühler	Meat probe sensor
8	1	1315.0105	Kupferdichtring für Einstechfühler	Copper washer for meat probe sensor
9	1	1112.0110	Sechskantmutter M 10	Hexagonal nut M10
10	1	8514.1023	Einfahrschiene links	Rail left
11	1	8514.1025	Sperrklinke f. Einfahrschiene rechts	Bolt for oven rack rail right
12	1	8514.1024	Einfahrschiene rechts	Rail right
13	1	2005.0302	Ablaufsieb	Outlet sieve
14	1	8514.1018	Reflektor kpl. f. Garraumbeleuchtung	Reflector unit for interior lighting
15	1	3024.0201	Halogengarraumlampe 10 W/12V/300°	Halogen bulb 10 W/12V/300°
16	1	5110.1023	Dichtungsrahmen innen	Internal gasket frame
17	1	5201.1000	Glas f. Garraumbeleuchtung	Glass for interior lamp
18	1	5110.1022	Dichtungsrahmen außen	External gasket frame
19	1	8514.1017	Andrückrahmen f. Garraumbeleuchtung	Press down frame for interior lighting
20	1	1008.0753	Sechskantschraube M 5x8	Hexagonal screw M5x8
21	2	8514.1064	Anschlagwinkel für Trichterblech kpl.	Holding bracket air baffle
-	4	1106.0360	Hutmutter M6 hohe Form	Cap nut M6, high shape
-	4	1206.0261	Federring B6	Spring washer B6
-	4	1306.0120	Unterlegscheibe A6.4	Washer A6.4
-	1	8817.1201	Kabel für Innenbeleuchtung	Cable for interior light
-	1	4001.1248	Porzellanklemme 2 polig	Porcelain connector 2 pin interior light

		Sonstiges	Miscellaneous
Pos. Pos.	Ersatz.Nr. Sp. Part No.	Bezeichnung	Description
1	1003.2260	Linsensenk-Blechschaube HC4,2x16	Raised countersunk head - self-tapping screw HC4,2x16
2	1004.2160	Sechskant Blechschaube A4,2x16	Hex self-tapping screw A4,2x16
3	1104.0821	Blechnutter B3,9	Climp B3,9
4	1107.0100	Schnellbefestiger d4.0 mm	Quick fastener d4.0 mm
5	1107.0101	Schnellbefestiger d5.0mm	Quick fastener d5.0mm
6	1107.0102	Schnellbefestiger d12mm	Quick fastener d12mm
7	1107.0103	Schnellbefestiger d3mm	Quick fastener d3mm
8	1311.2260	Schraubenrosette 5x12,5	Rosette 5x12,5
9	1901.0042	Blechklammer für Außenmantel	Clamp for exterior cabinet
10	1901.0044	Blechklammer für Deckel bis 05/95	Clamp for cover up to 05/95
11	2001.0042	Loctite Schraubensicherung 10ml	Screw locking, heat resistant 10ml
12	2005.0500	Lenkrolle d/125-10.3 ohne Feststeller	Castor d/125-10.3 without stopper
13	2005.0600	Lenkrolle d/125-10.3 mit Feststeller	Castor d/125-10.3 with stopper
14	3016.1409	Magnet rund Tischgeräte	Magnet round table models
15	3016.1412	Magnet eckig Standgeräte	Magnet angular floor models
16	4002.0100	Flachsteckhülse 2,5x6,3	Cable shoes 2,5x6,3
17	4004.0100	Aderendhülse 1,0mm ²	Wire end sleeve 1,0mm ²
18	4004.0101	Aderendhülse 1,5mm ²	Wire end sleeve 1,5mm ²
19	4004.0102	Aderendhülse 2,5mm ²	Wire end sleeve 2,5mm ²
20	4004.0103	Aderendhülse 4mm ²	Wire end sleeve 4mm ²
21	4004.0104	Aderendhülse 6mm ²	Wire end sleeve 6mm ²
22	4004.0105	Aderendhülse 10mm ²	Wire end sleeve 10mm ²
23	4004.0106	Aderendhülse 16mm ²	Wire end sleeve 16mm ²
24	4004.0114	Aderendhülse 0,75mm ²	Wire end sleeve 0,75mm ²
25	4005.0101	Kabelbinder 145mm lang	Cable strap 145mm long
26	4005.0102	Kabelbinder 100mm lang	Cable strap 100mm long
27	5003.0300	Isolierung Dampfgenerator 1250x1250mm	Insulation steam generator 1250x1250mm
28	5006.0200	Tube Silikon E41	Silicone (tube) E41
29	5006.0500	Kleber Isolierung Dampfgenerator 310ml	Adhesive isulation steam generator 310ml
30	6004.0100	Handdruck Sprühpistole	Spray-pistol
31	6004.0101	Verlängerung Handdruck Sprühpistole	Lengthening piece for spray-pistol
32	6004.0102	Dichtung Handdruck Sprühpistole	Gasket for spray-pistol
33	6004.0203	Entkalker-Fußpumpe	Descaler foot pump
34	6006.0101	RATIONAL Spezialreiniger	RATIONAL special cleaning agent
35	6006.0110	RATIONAL Entkalker	RATIONAL descaler
36	6021.1028	Griff für Hordengestellwagen	Handle for mobile oven rack
37	9003.0202	Unimoly plus, 180 °C	Unimoly plus, 180 °C
38	9006.0850	Metallwaschcreme	Stainless steel cleaning paste

Motor und Lüfterrad Motor and fan wheel	Spannung Voltage	Baugruppe Group	Ausgabe Edition	gültig ab Seriennummer Applicable from Serial.No.
	3 N AC 400V 50Hz	6	6.1.2	C61D95057001

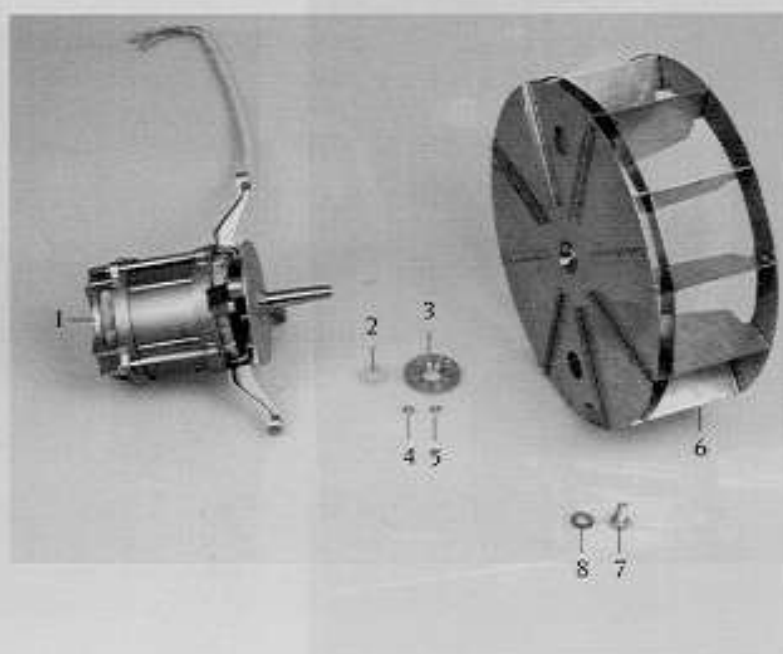

Pos.	St.	Ersatz.Nr.	Bezeichnung	Description
Pos.	Pcs.	Sp. Part No.		
1	1	3100.1002	Lüftermotor	Fan motor
-	4	1108.0260	Sechskantmutter M 8	Hexagonal nut M8
-	4	1208.0260	Federring B8	Spring washer B8
-	1	8514.1202	Halteplatte für Lüftermotor	Fan motor holding plate
-	4	1315.0101	Kupferdichtung 6x10 mm	Copper gasket 6x10 mm
2	1	5001.0207	Motorwellendichtung	Motor shaft gasket type
3	1	2016.0876	Dichtungsflansch für Motorwelle	Gasket flange for engine shaft
4	4	1306.0120	Unterlegscheibe A6,4	Washer A6.4
5	4	1106.0220	Sechskantmutter M6 flach	Hexagonal nut M6 flat
6	1	2012.0502	Lüfterrad	Fan wheel
7	1	1010.0762	Sechskantschraube M 10x20	Hexagonal screw M10x20
8	1	1328.0102	Sperrkantscheibe A10,2	Safety washer A10.2

Motor und Lüfterrad Motor and Fan Wheel	Spannung Voltage	Baugruppe Group	Ausgabe Edition	gültig ab Seriennummer Application from Serial.No.
	3 N AC 400V 50Hz	6	6.1.1	C61D93065001

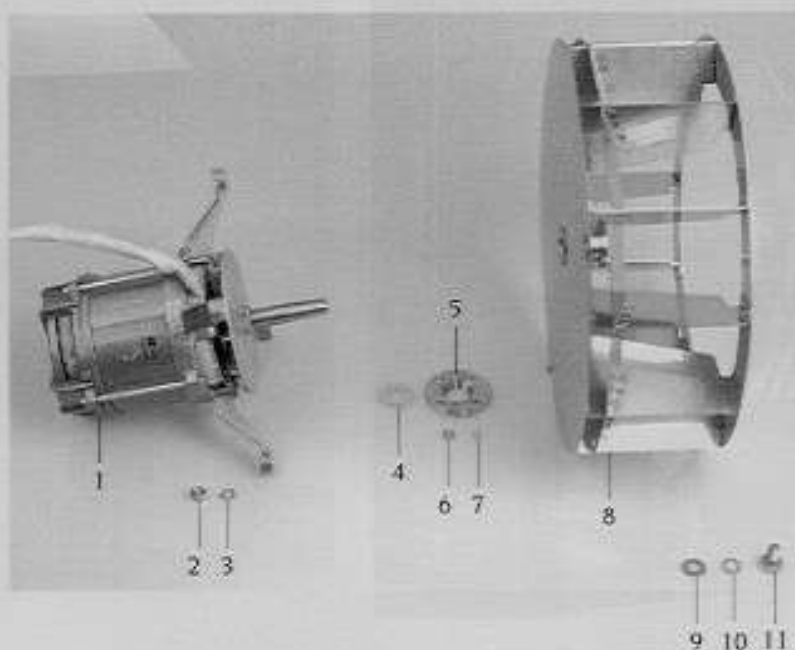
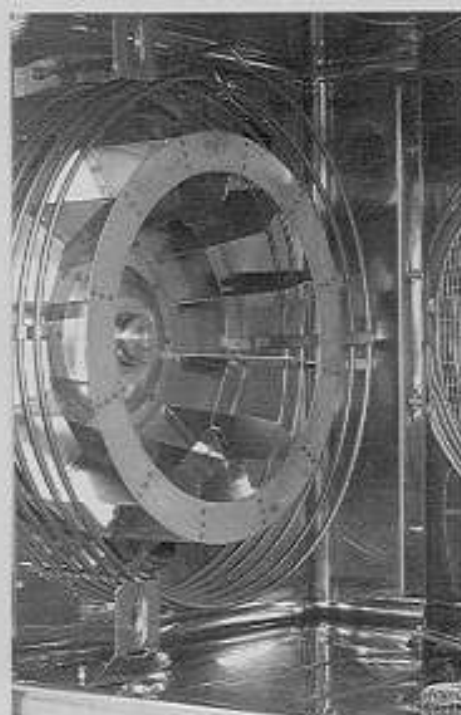

Pos.	St.	Ersatz.Nr.	Bezeichnung	Description
Pos.	Pcs.	Sp. Part No.		
1	1	3100.1002	Lüftermotor	Fan motor
2	4	1108.0260	Sechskantmutter M 8	Hexagonal nut M8
3	4	1208.0160	Zahnscheibe d 8,4	Toothed disc d 8.4
4	1	5001.0207	Motorwellendichtung	Motor shaft gasket
5	1	2016.0876	Dichtungsflansch für Motorwelle	Gasket flange for motor shaft
6	4	1106.0220	Sechskantmutter M6 flach	Hexagonal nut M6 flat
7	4	1315.0101	Kupferdichtung 6x10	Copper gasket 6x10
8	1	2012.0900	Lüfterrad	Fan wheel
9	1	1210.0160	Unterlegscheibe A 10,5	Washer A 10.5
10	1	1310.0160	Zahnscheibe A 10,5	Toothed disc A 10.5
11	1	1010.0760	Sechskantschraube M 10x16	Hexagonal screw M10x16

Ablöschkasten Quenching box	Spannung Voltage	Baugruppe Group	Ausgabe Edition	gültig ab Seriennummer Applicable from Serial.No.
	3 N AC 400V 50Hz	10	10.1.2	C61D95057001

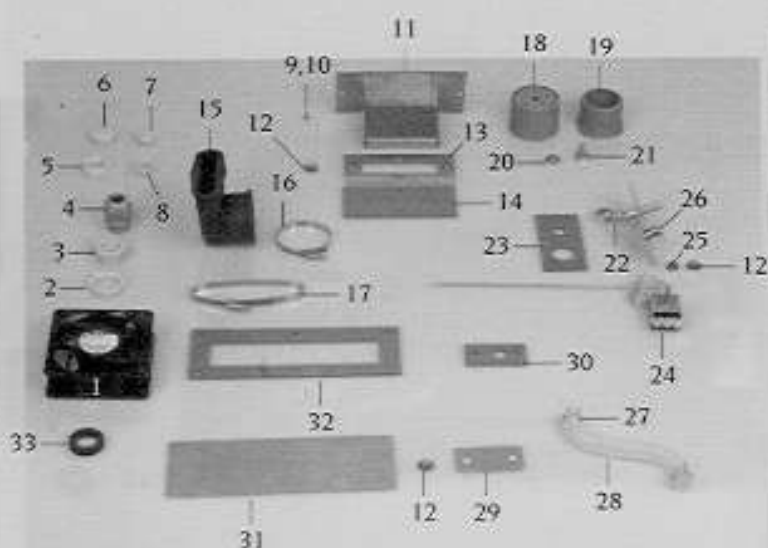
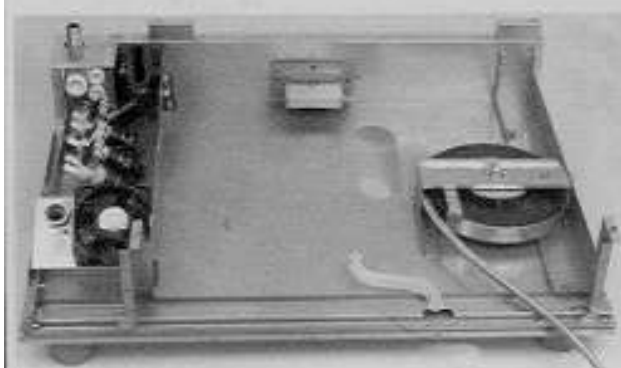

Pos. Pos.	St. Pcs.	Ersatz.Nr. Sp. Part No.	Bezeichnung	Description
-	-	2067.0050	Silikonschlauch 1m	Silicone hose 1m
1	1	3101.1008	Kühllüfter	Cooling motor
2	1	4007.0206	Sechskantmutter für PG 29	Hex screw for PG 29
3	1	4007.0406	Reduzierstück PG 29/21	Reducing socket PG 29/16
4	1	4007.0405	Kabelverschraubung PG 16	Screw-type conduit fitting PG 16
5	1	4007.0526	Sechskantmutter für PG 21	Hex screw for PG 21
6	1	4007.0615	Stopfen PG 21	Plug PG 21
7	2	4007.0614	Stopfen PG 13,5	Plug PG 13,5
8	2	4007.0521	Sechskantmutter für PG 13,5	Hex screw for PG 13,5
9	3	1004.2164	Sechskant Blechschraube A4,2x16	Hex self-tapping screw A4,2x16
10	3	1304.0160	Unterlegscheibe A4,3	Washer A4,3
11	1	8666.1200	Überlaufkanal geschweißt	Overflow box
12	18	1106.0801	Sechskant-Combi-Mutter M 6	Hexagonal combination nut M6
13	1	2715.1203	Flansch hinten	Flange for overflow box
14	1	5110.1204	Dichtung Überlaufkanal	Gasket for flange overflow box
15	1	2118.1202	Manschette Entlüftungsrohr unten	Rubber form piece venting pipe up
16	1	2066.0505	Schlauchschelle 70-90mm	Hose clamp 70-90mm
17	1	2066.0524	Schlauchschelle 90-110	Hose clamp 90-110
18	4	2039.0112	Fußoberteil	Upper part of pedestal
19	4	2039.0113	Fußunterteil	Lower part of pedestal
20	4	2750.1020	Unterlegscheibe A10,5	Washer A10,5
21	4	1010.0760	Sechskantschraube M 10x16	Hexagonal screw M10x16
22	1	8666.1212	Ablöschdüse D1 kpl.	Quenching nozzle D1 cpl.
23	1	5110.1201	Dichtung Ablöschdüse D1	Gasket for quenching nozzle D1
24	1	3014.0312	Thermostat Ablöschung	Thermostat for quenching
25	1	2022.0100	Silikon-Dichtscheibe d 12x2	Silicone gasket d 12x2
26	1	4007.0600	Kabelverschraubung PG 9	Screw-type conduit fitting PG 9
27	2	2066.0525	Schlauchklemme 22,1mm	Hose clamp 22,1mm
28	1	2112.1025	Form-Entleerschlauch für Tropfwanne	Emptying hose for drip pan
29	1	2760.1223	Deckflansch Ablöschdüse D1	Flange quenching D1
30	1	5110.1202	Dichtung Ablöschdüse D2	Gasket for quenching nozzle D2
31	1	2715.1034	Flansch vorne	Flange quenching D2
32	1	5110.1203	Dichtung für Revisionsflansch	Gasket revision flange
33	1	2022.0105	Durchführungsstülle d 26mm	Lead-in grommet d 26 mm

Ablöschkasten
Quenching box

Spannung
Voltage
3 N AC 400V 50Hz

Baugruppe
Group
10

Ausgabe
Edition
10.2.1

gültig ab Seriennummer
Applicable from Serial.No.
C61D95057001

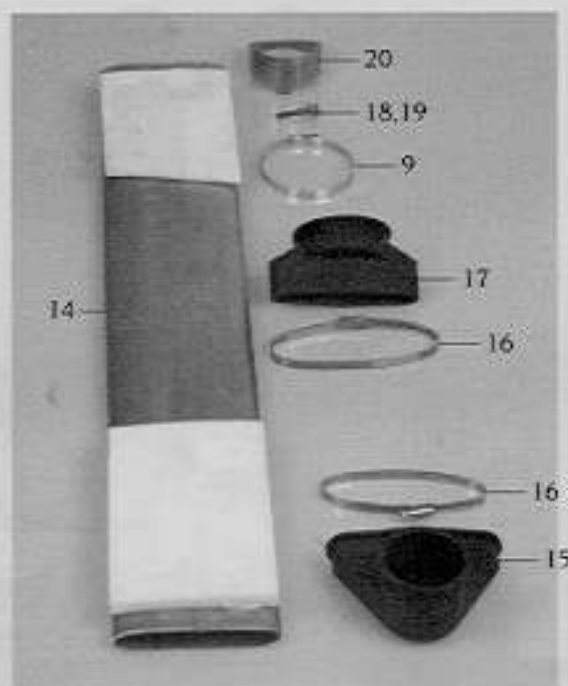
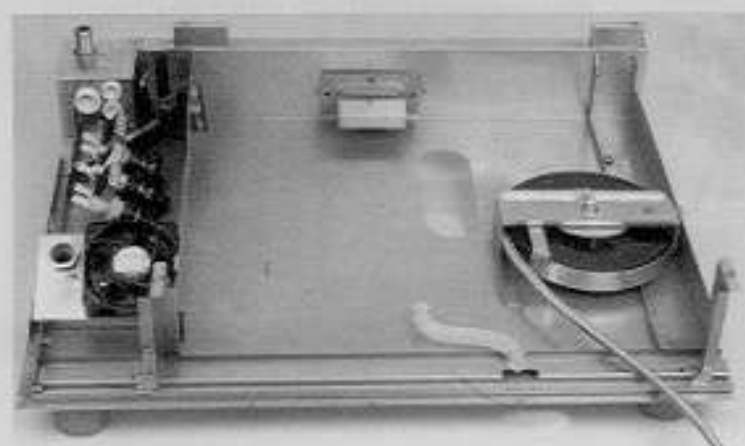

Pos.	St.	Ersatz.Nr.	Bezeichnung	Description
Pos.	Pcs.	Sp. Part No.		
1	1	2064.1000	Überdruckgewicht	Overpressure weight
2	1	2064.1003	Unterdruckdichtung	Vacuum/depression gasket
3	1	2064.1002	Unterdruckfeder	Vacuum/depression spring f
4	1	1105.0122	Sechskant-Combi-Mutter M 5	Hexagonal combination nut M5
5	1	1107.0100	Schnellbefestiger 4,0 mm	Quick fastener 4.0 mm
6	1	2064.1004	Überdruckgewichtdichtung	Overpressure weight gasket
7	1	2064.1000	Überdruckgewicht	Overpressure weight
8	1	2066.0504	Schlauchselle 40-60mm	Hose clamp 40-60mm
9	2	2066.0505	Schlauchselle 70-90mm	Hose clamp 70-90mm
10	1	2118.1200	Manschette Be- und Entlüftung	Form rubber humidity control
11	2	8455.1207	Glockenhalter	Vent cover bracket
12	1	2910.1206	Abstandshalter für Glocke	Distance holder for vent cover
13	1	8455.1209	Glocke Typ	Vent cover 61/101
14	1	2910.1203	Entlüftungsrohr	Venting pipe quenching chamber
15	1	2118.1202	Manschette Entlüftungsrohr unten	Rubber form piece venting pipe up
16	2	2066.0524	Schlauchselle 90-110	Hose clamp 90-110
17	1	2118.1201	Manschette Entlüftungsrohr oben	Rubber form piece venting pipe down
-	1	2760.1253	Lochscheibe d64mm	Protection plate d64mm
18	1	1006.0764	Sechskantschraube M 6x25	Hexagonal screw M 6x25
19	1	1306.0120	Unterlegscheibe A6.4	Washer A6.4
20	1	8455.1215	Entlüftungsstutzen	Venting stud

Ablöschkasten Quenching box 2	Spannung Voltage 3 N AC 400V 50Hz	Baugruppe Group 10	Ausgabe Edition 10.1.2	gültig ab Seriennummer Applicable from Serial.No. C61D95057001
----------------------------------	---	--------------------------	------------------------------	--

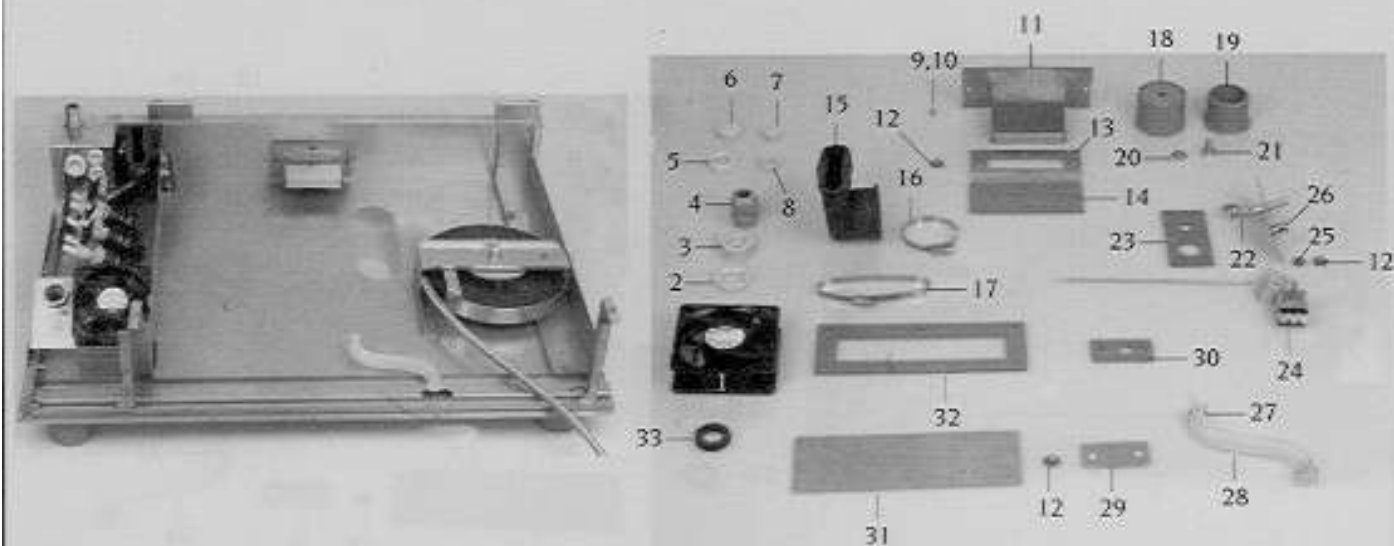

Pos.	St.	Ersatz.Nr.	Bezeichnung	Description
Pos.	Pcs.	Sp. Part No.		
-	-	2067.0050	Silikonschlauch 1m	Silicone hose 1m
1	1	3101.1008	Kühllüfter	Cooling motor
2	1	4007.0206	Sechskantmutter für PG 29	Hex screw for PG 29
3	1	4007.0406	Reduzierstück PG 29/21	Reducing socket PG 29/16
4	1	4007.0405	Kabelverschraubung PG 16	Screw-type conduit fitting PG 16
5	1	4007.0526	Sechskantmutter für PG 21	Hex screw for PG 21
6	1	4007.0615	Stopfen PG 21	Plug PG 21
7	2	4007.0614	Stopfen PG 13,5	Plug PG 13,5
8	2	4007.0521	Sechskantmutter für PG 13,5	Hex screw for PG 13,5
9	3	1004.2164	Sechskant Blechschraube A4,2x16	Hex self-tapping screw A4,2x16
10	3	1304.0160	Unterlegscheibe A4,3	Washer A4,3
11	1	8666.1200	Überlaufkanal geschweißt	Overflow box
12	18	1106.0801	Sechskant-Combi-Mutter M 6	Hexagonal combination nut M6
13	1	2715.1203	Flansch hinten	Flange for overflow box
14	1	5110.1204	Dichtung Überlaufkanal	Gasket for flange overflow box
15	1	2118.1202	Manschette Entlüftungsrohr unten	Rubber form piece venting pipe up
16	1	2066.0505	Schlauchschelle 70-90mm	Hose clamp 70-90mm
17	1	2066.0524	Schlauchschelle 90-110	Hose clamp 90-110
18	4	2039.0112	Fußoberteil	Upper part of pedestal
19	4	2039.0113	Fußunterteil	Lower part of pedestal
20	4	2750.1020	Unterlegscheibe A10,5	Washer A10,5
21	4	1010.0760	Sechskantschraube M 10x16	Hexagonal screw M10x16
22	1	8666.1212	Ablöschdüse D1 kpl.	Quenching nozzle D1 cpl.
23	1	5110.1201	Dichtung Ablöschdüse D1	Gasket for quenching nozzle D1
24	1	3014.0312	Thermostat Ablöschung	Thermostat for quenching
25	1	2022.0100	Silikon-Dichtscheibe d 12x2	Silicone gasket d 12x2
26	1	4007.0600	Kabelverschraubung PG 9	Screw-type conduit fitting PG 9
27	2	2066.0525	Schlauchklemme 22,1mm	Hose clamp 22,1mm
28	1	2112.1025	Form-Entleerschlauch für Tropfwanne	Emptying hose for drip pan
29	1	2760.1223	Deckflansch Ablöschdüse D1	Flange quenching D1
30	1	5110.1202	Dichtung Ablöschdüse D2	Gasket for quenching nozzle D2
31	1	2715.1034	Flansch vorne	Flange quenching D2
32	1	5110.1203	Dichtung für Revisionsflansch	Gasket revision flange
33	1	2022.0105	Durchführungsstülpe d 26mm	Lead-in grommet d 26 mm

Dampfgenerator Steam Generator	Spannung Voltage	Baugruppe Group	Ausgabe Edition	gültig ab Seriennummer Application from Serial.No.
	3 N AC 400V 50Hz	4	4.1.1	C61D93065001

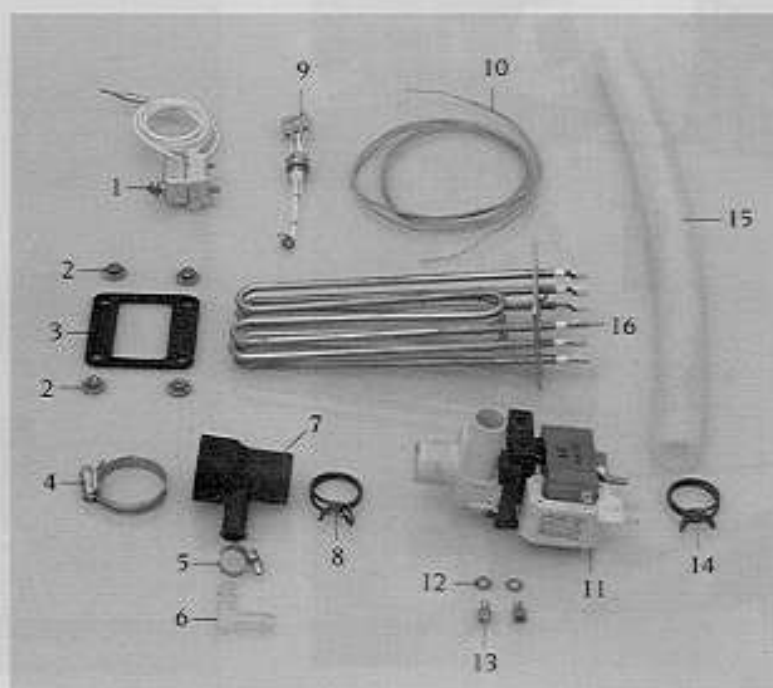
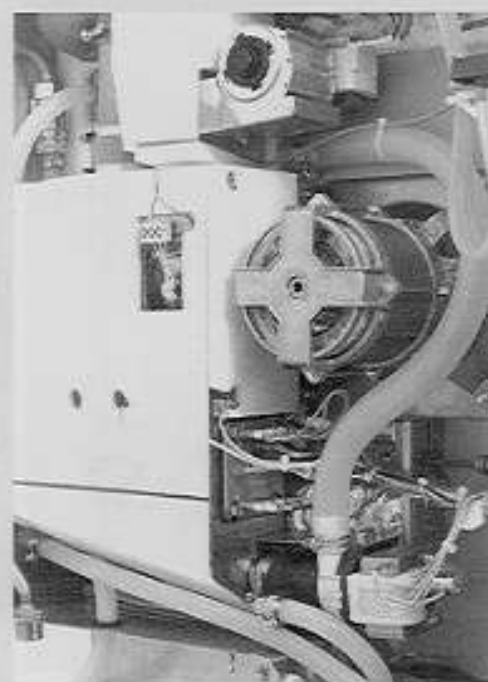

Pos.	St.	Ersatz.Nr.	Bezeichnung	Description
Pos.	Pcs.	Sp. Part No.		
-	1	8350.1001	Dampfgenerator kpl.	Steam generator unit
1	1	3014.0300	Trockengehschutz 125 °	Dry up protector 125 °
-	1	2740.1040	Klemmblech Dampfgenerator	Clamping plate for steam generator
2	4	1106.0801	Sechskant-Combi-Mutter M 6	Hexagonal combination nut M6
3	1	5110.1003	Dichtung f. Tauchheizkörper	Gasket for heating element
4	1	2066.0507	Schlauchschelle 32-50mm	Hose clamp 32-50mm
5	2	2066.0205	Schlauchschelle 12-18mm	Hose clamp 12-18mm
6	1	2062.0301	Winkelstück Kunststoff WS 10	Elbow piece plastic WS 10
7	1	2118.1000	Pumpenanschlußstutzen	Pump connection spout
8	1	2066.0519	Schlauchklemme 35,6mm	Hose clamp 35,6mm
9	1	3002.0402	Füllstandselektrode 90mm.	Filling level electrode 90 mm
10	1	3014.0165	Thermoelement Dampfgenerator	Thermo element steam generator
11	1	3002.1000	Entleerungspumpe 200-240V 50/60Hz	Emptying pump 200-240V 50/60Hz
12	2	1306.0120	Unterlegscheibe A6,4	Washer A6,4
13	2	1006.0621	Innensechskantschraube M 6x12	Allen screw M6x12
14	1	2066.0522	Schlauchklemme 31,3mm	Hose clamp 31,3mm
15	1	2112.1011	Entleerschlauch 22x4x550	Emptying hose 22x4x550
16	1	3201.1000	Tauchheizkörper 3x3 kw/230V	Heating element 3x3 kw/230V

Dampfgenerator Steam generator	Spannung Voltage	Baugruppe Group	Ausgabe Edition	gültig ab Seriennummer Applicable from Serial.No.
	3 N AC 400V 50Hz	4	4.1.2	C61D95057001

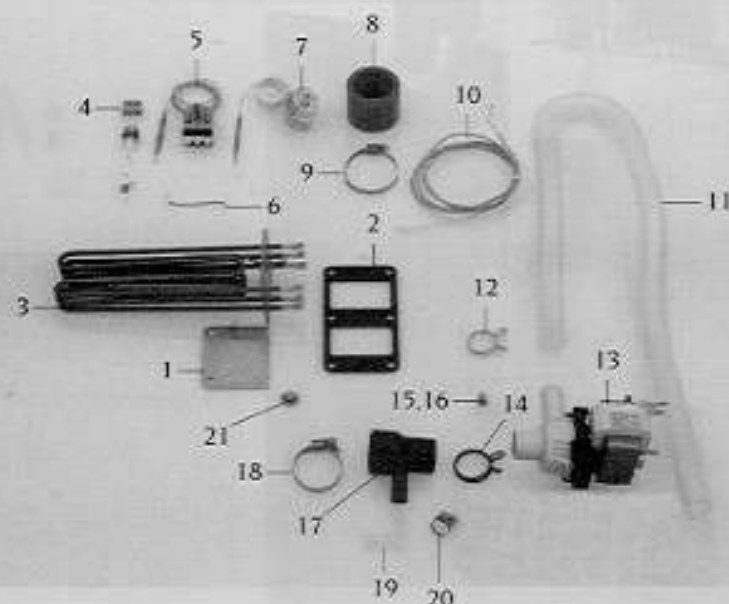
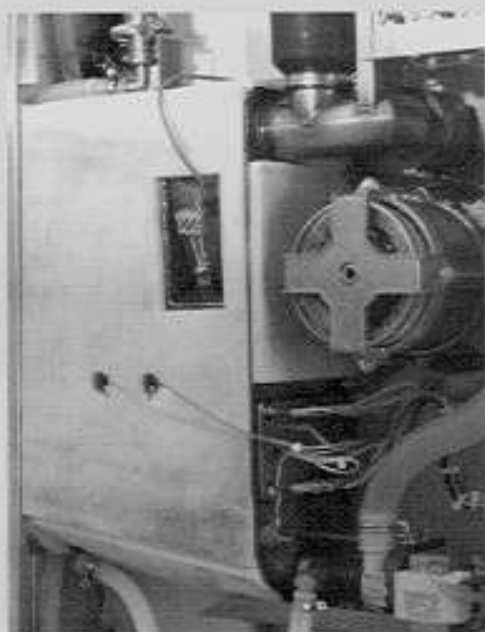

Pos.	St.	Ersatz.Nr.	Bezeichnung	Description
Pos.	Pcs.	Sp. Part No.		
-	1	8720.1203	Dampfgenerator kpl. 230V/50Hz	Steam generator cpl. 230V/50Hz
-	1	8720.1200	Dampfgenerator isoliert	Steam generator insulated
-	1	5212.1200	Isolierung für Dampfgenerator	Insulation for steam generator
1	1	2150.1203	Flansch für Dampfgenerator	Blanking plate
2	1	5110.1200	Dichtung f. Tauchheizkörper	Gasket for heating element
3	1	3201.1200	Tauchheizkörper 3x3 kw 230V	Heating element 3x3 kw 230V
4	1	3002.0402	Füllstandselektrode 90mm	Filling level electrode 90mm
5	1	3014.0314	Thermostat Dampfgenerator	Thermostat for steam generator
6	2	2740.1040	Klemmblech Dampfgenerator	Clamping plate for steam generator
7	1	3014.0300	Trockengehschutz 125°C	Dry up protector 125°C
8	1	2112.1006	Dampfschlauch 50x7mm	Steam hose 50x7mm
9	2	2066.0300	Schlauchschelle 50-70mm	Hose clamp 50-70mm
10	1	3014.0165	Thermoelement Dampfgenerator	Thermo element steam generator
11	1	2112.1201	Entleerschlauch	Emptying hose
12	2	2066.0522	Schlauchklemme 31,3mm	Hose clamp 31,3mm
13	1	3002.1000	Entleerungspumpe 200-240V 50/60Hz	Emptying pump 200-240V 50/60Hz
14	1	2066.0519	Schlauchklemme 35,6mm	Hose clamp 35,6mm
15	2	1006.0621	Innensechskantschraube M 6x12	Allen screw M6x12
16	2	1306.0120	Unterlegscheibe A6,4	Washer A6,4
17	1	2118.1000	Pumpenanschlußstutzen	Pump connection spout
18	1	2066.0507	Schlauchschelle 32-50mm	Hose clamp 32-50mm
19	1	2062.0301	Winkelstück Kunststoff WS 10	Angle piece plastic WS 10
20	2	2066.0205	Schlauchschelle 12-18mm	Hose clamp 12-18mm
21	6	1106.0801	Sechskant-Combi-Mutter M 6	Hexagonal combination nut M6

Wasseranschluß Water supply	Spannung Voltage	Baugruppe Group	Ausgabe Edition	gültig ab Seriennummer Applicable from Serial.No.
	3 N AC 400V 50Hz	9	9.1.2	C61D95057001

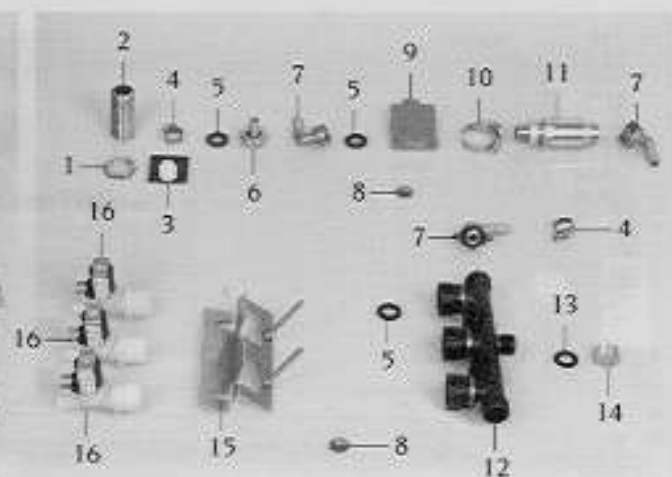
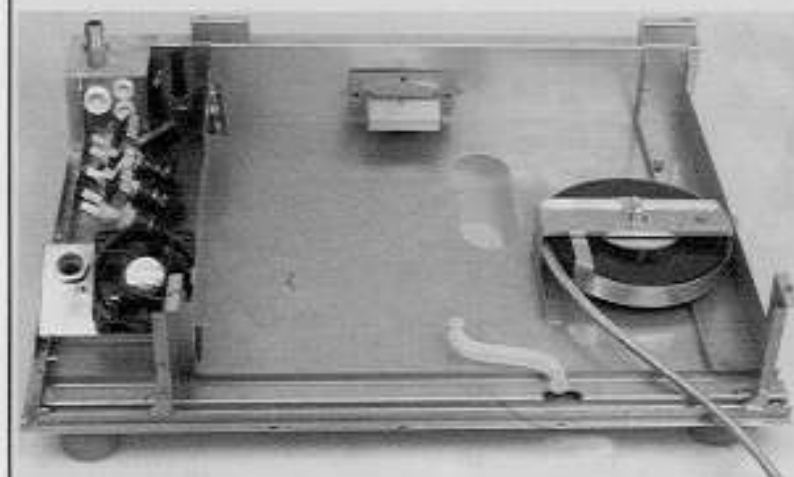

Pos.	St.	Ersatz.Nr.	Bezeichnung	Description
Pos.	Pcs.	Sp. Part No.		
-	-	2067.0050	Silikon Schlauch 1m	Silicone hose 1m
1	2	2062.0313	Kontermutter G 3/4	Lock-nut G 3/4
2	1	1500.1582	Gewindenippel G3/4"	Thread nipple G3/4"
3	1	1900.0202	Wasserfilter grob	Water filter coarse
4	9	2066.0205	Schlauchselle 12-18mm	Hose clamp 12-18mm
5	7	5110.1024	Dichtung für Verschraubung G 3/4"	Gasket for G3/4" threaded joint
6	1	2062.0314	Geradeverschraubung G 3/4	Straight threaded joint G 3/4
7	3	2062.0203	Winkelverschraubung G 3/4x10	Elbow screw point G 3/4x10
8	4	1106.0801	Sechskant-Combi-Mutter M 6	Hexagonal combination nut M6
9	1	2717.1200	Haltewinkel für Armaturenkombination	Mounting bracket for double check valve
10	1	2066.0503	Schlauchselle 25-40mm	Hose clamp 25-40mm
11	1	2069.0103	Armaturenkombination	Valve unit with non-return valve
12	1	8664.1007	Wasserverteiler	Water distribution unit
13	1	5012.0539	Dichtung für Verschraubung G 1/2"	Gasket for G1/2" threaded joint
14	1	1500.1261	Verschlußkappe G1/2"	Screw cap G1/2"
15	1	8664.1211	Halter für Wasserverteiler	Holding bracket for water manifold
16	3	3002.0331	Einfachmagnetventil kpl. 220-240V/50Hz	Single solenoid valve unit 220-240V/50Hz